

SPECIFICATIONS

Holding Power	1200 Lbs.
Dual Voltage	450 / 225 mA @ 12/24VDC
Sensor	Magnetic Bond Sensor and Door Position Sensor Standard
Cable	3 Ft. cable
Finish	Brushed stainless steel housing
Conduit Fitting	1/2" x 3/4"
Dimensions	8-11/16" L x 2-1/2" H x 1-5/8" D

MODEL	DESCRIPTION	
1575U	Single EMLock® with magnetic bond and door status sensors	451.00
1576U	Single EMLock® face drilled mounting with magnetic bond and door status sensors	451.00



1575-BK



1576-AB



1576-BK



1576-MP



1576-ZB

ACCESSORIES

Add to List

MODEL	DESCRIPTION	
For sliding gate applications		
1576-BK	Mounting Bracket for 1576	83.00
1576-AB	Armature Mounting Bracket for 1576	83.00
For swinging gate or top jamb door application		
1575-BK	Mounting Bracket for 1575	104.00
1576-MP	Lock Mounting Plate for 1576	57.00
1576-ZB	Lock Mounting Bracket for 1576 (Includes 1576-MP)	166.00

1575U FOR SWINGING GATES

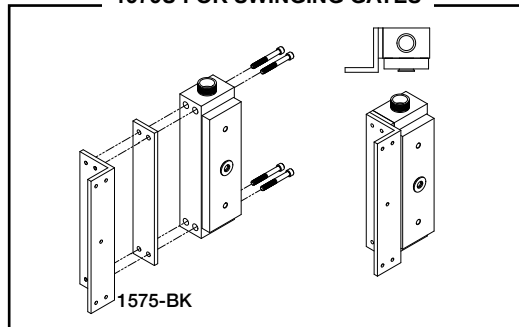

1575U FOR OUTSWING DOORS

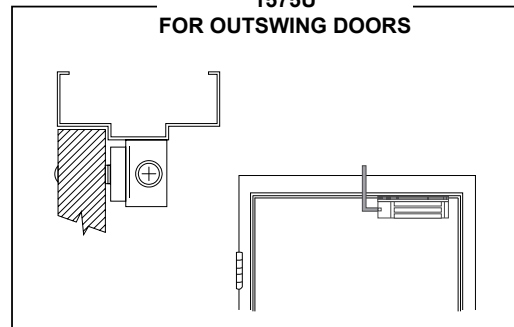

1576U FOR SWINGING GATES

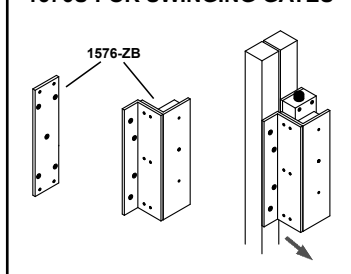

1576U FOR SLIDING GATES

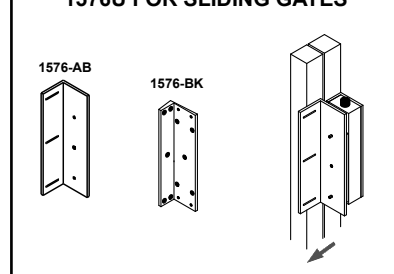

1576U TOP JAMB MOUNT FOR INSWING DOORS

